

# K-Systems<sup>®</sup>

---

## G73 Block Warmer User Manual

+45 46 79 02 02 | [sales@coopersurgical.com](mailto:sales@coopersurgical.com) | [fertility.coopersurgical.com](http://fertility.coopersurgical.com)



 **CooperSurgical, Inc.**  
95 Corporate Drive, Trumbull, CT 06611, USA  
Document K22065UM(2) | DRF 5385 | 10 November 2020

CooperSurgical<sup>®</sup>



## CONTENTS

<b>SECTION 1 – PREFACE</b>	<b>1</b>
Copyright	1
<b>SECTION 2 - SAFETY WARNINGS</b>	<b>2</b>
Glossary of Safety/Information Symbols	2
<b>SECTION 3 - PRODUCT OVERVIEW</b>	<b>3</b>
Unpacking and Inspection	3
Accessories	3
Optional Equipment	3
Intended Use	4
General Description	4
<b>SECTION 4 - BASIC OPERATION</b>	<b>5</b>
Features and Operation	5
Assembling the G73	5
Connection to the Mains	5
Start of Apparatus	5
Keyboard Functions	5
Operating the Heated Area	5
Temperature Setting and Control	6
Combination Keys	6
Temperature Alarm	6
Warming Up	7
<b>SECTION 5 - MENU FUNCTION</b>	<b>8</b>
Overview of Options	9
Unit	10
RS232	11
Tune	12
INT.T	12
TI.St	13
St.St	14

## CONTENTS

Heat	15
A-ST	16
Hour	17
Rest	18
<b>SECTION 6 - CARE AND MAINTENANCE</b>	<b>19</b>
Cleaning	19
Preparation at the Point of Use	19
Periodic Cleaning	19
Disinfection	19
Drying	19
Calibration	19
Disposal of electrical and electronic equipment.	20
<b>SECTION 7 - TROUBLESHOOTING</b>	<b>21</b>
<b>SECTION 8 - TECHNICAL DATA</b>	<b>22</b>
<b>SECTION 9 - WARRANTY INFORMATION AND LIMITS ON LIABILITY</b>	<b>23</b>
<b>SECTION 10 - RETURNING PRODUCT</b>	<b>24</b>
Returned Goods Policy	24
Customer Service Contact Details	25
US Only Customers Contact Details	25
<b>SECTION 11 - CUSTOMER SERVICE CONTACT INFORMATION</b>	<b>26</b>
European Service Representatives	26
US Service Representatives	26

## SECTION 1 – PREFACE

### Copyright

This manual contains information that is subject to copyright. All rights reserved. This manual should not be photocopied, otherwise copied or distributed, completely or in part, without the approval of CooperSurgical, Inc.

Users of K-SYSTEMS CooperSurgical, Inc products should not hesitate to contact us if there are any unclear points or ambiguities in this manual.

CooperSurgical, Inc.

Phone: +1 (203)601-9818

International Phone: +45 46 79 02 02

sales@coopersurgical.com

fertility.coopersurgical.com



CooperSurgical, Inc.  
95 Corporate Drive  
Trumbull, CT 06611, USA















If the equipment is used in a manner not specified by this manual, the safety of the user may be at risk and the equipment may be damaged. Always use the equipment as outlined in this instruction manual.

## SECTION 2 - SAFETY WARNINGS

### Glossary of Safety/Information Symbols

Source: BS EN 15223-1 and BS EN 60601-1

Symbol	Meaning
	In accordance with Low Voltage Directive 2014-35-EU
	Consult instructions for use - <a href="http://coopersurgical.com">coopersurgical.com</a> Hard copies available on request
	Indicates the need for the user to consult the instructions for use for important cautionary information such as warnings and precautions that cannot, for a variety of reasons, be presented on the medical device itself.
	Manufacturer
	Date of manufacture
	Catalogue or Part number
	Serial number
	Do not dispose of product with normal waste. Dispose of in accordance with the EU WEEE Directive. (See Care and Maintenance section.)
	This way up
	Fragile, handle with care
	Stacking limited to 3 units
	Keep dry

## SECTION 3 - PRODUCT OVERVIEW

## Unpacking and Inspection

- Unpack the equipment.
- Check the packing list to insure all accessories are there.
- Examine the packing material carefully for separately packed items.
- Check the incubator for external surface damage.
- Check that the display is not broken or damaged.

## Accessories

## Standard Accessories

24 volts main adapter (PSU)  
Order code: K51122



## Mains Cable

Order code: 1212807



## Optional Equipment

Optional equipment consists of a range of warming blocks. Please contact your local CooperSurgical distributor or CooperSurgical, Inc. for details about the full range of warming blocks.

## Warming block B01

Holds seven tubes Ø17 mm  
Falcon 352001  
Order code: 26001



## Warming block B06

Holds twelve tubes of  
Ø12mm  
Order code: 26006



## Warming block B03

Holds twelve tubes of Ø12mm  
Falcon 352003  
Order code: 26003



## Warming block B08

Holds ten tubes of  
Ø17mm  
Falcon 352001  
Order code: 26008



## Warming block B04

Holds four tubes of  
25ml – Ø23,5mm  
Order code: 26004



## Warming block B40

Holds one IVF  
MediaFlask of 125ml  
Order code: 26055



## Intended Use

The K-SYSTEMS CooperSurgical, Inc. G73 Block Warmer is designed for warming media and for maintaining a stable temperature of cells and specimens in a test tube.

## General Description

The stainless steel chamber maintains a preset temperature in the range ambient to 42.9°C. The temperature is electronically controlled and can be read on the display in increments of 0.1°C

3

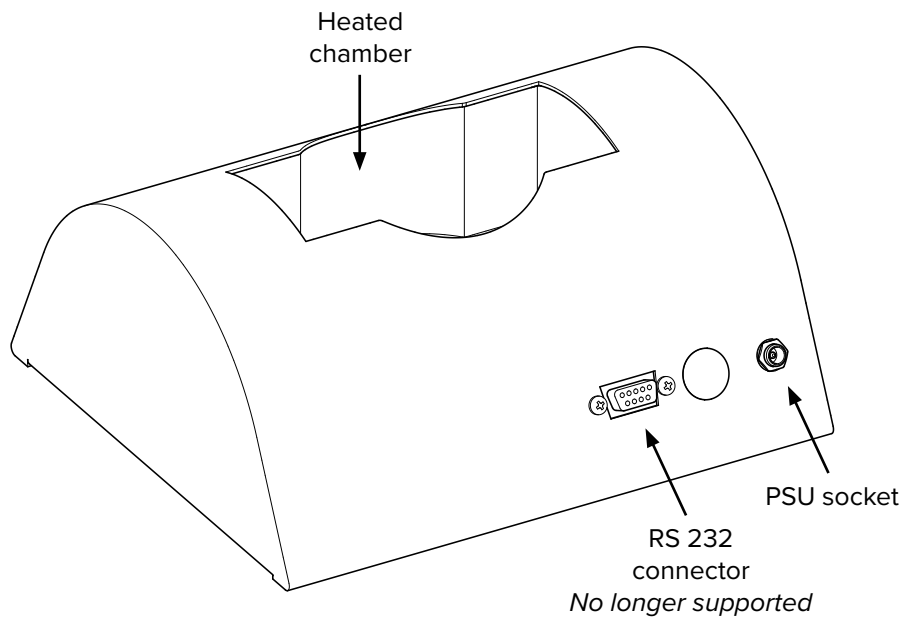



**SECTION 4 - BASIC OPERATION**

**Features and Operation**  
**Assembling the G73**

No assembly needed. Just follow directions in section 5 and the unit is ready for use.

**Connection to the Mains**

The mains voltage is automatically regulated to the correct level by the mains adapter (PSU). Connect the G73 to the mains supply using the enclosed PSU.

**Start of Apparatus**

To power up the unit, press the heat ON/OFF button on button on the keyboard. The display will indicate the current temperature.

**Keyboard Functions**

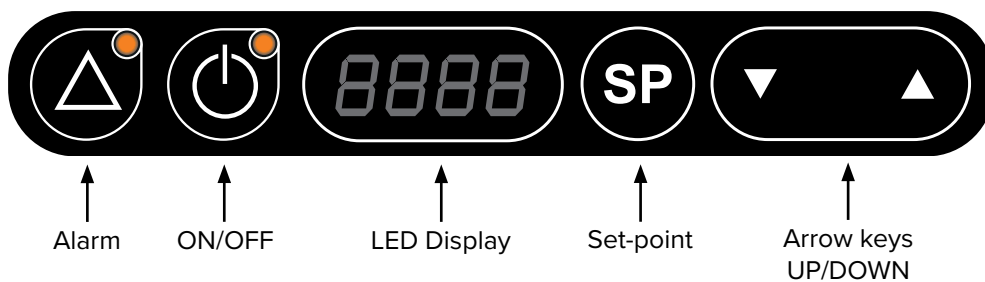



**Operating the Heated Area**

Action	Key	
Press ON/OFF key to show the actual temperature.		





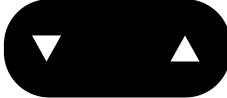

## Temperature Setting and Control

The display indicates the average temperature of the bottom of chamber. The displayed temperature is updated 4 times every second.

Action	Key
Press set-point key until set temperature is shown.	
Press and hold set-point key.	
Press arrow keys to raise or lower the temperature. When the desired temperature is reached, let go of the set-point key.	



*Note: The set-point can be adjusted to a reading between ambient and 42.0°C.*

## Combination Keys

Action	Key	Display
Press alarm and UP key.	 + 	The keyboard is locked.
Press alarm and arrow UP key.	 + 	The keyboard is unlocked.
Press Heat ON/OFF and set-point key.	 + 	Switches between temperature and time.

## Temperature Alarm

The temperature alarm indicates too high or too low temperature. The alarm will be activated if the temperature rises or falls more than 0.5°C from the set point. There will be an acoustic signal and the red LED light in the alarm key will be activated.

Action	Key
Press alarm key to mute the acoustic signal.	
Press alarm key once again to bring the signal back on.	

*Note: The red LED light and the acoustic signal will turn off when the temperature stabilizes to the set-point level*

## Warming Up

Warming up from 20.0°C to set-point takes less than 30 minutes, under normal conditions.

When a cold item is placed on the heated area it may need up to 40 minutes to stabilize, depending on the thermal mass of the object and the initial temperature.





G73 can hold various types of warming blocks as shown below.



*Note: Always place a warming block in the chamber during warm up.*

## SECTION 5 - MENU FUNCTION

The user can access a number of advanced functions via the menu.

Action	Key	Display
Press and hold UP+DOWN key for 3 seconds to enter the menu. The first option "UNIT" will appear in the display.		
Press UP/DOWN key to navigate within the Menu.		
While holding the set-point key in, press either the arrow UP or arrow DOWN key to change values within the options.		
Press and hold UP+DOWN key for 3 seconds again to exit the menu.		

The menu consists of the 10 options listed below. For further detail see the description on the following pages.

Overview of Options

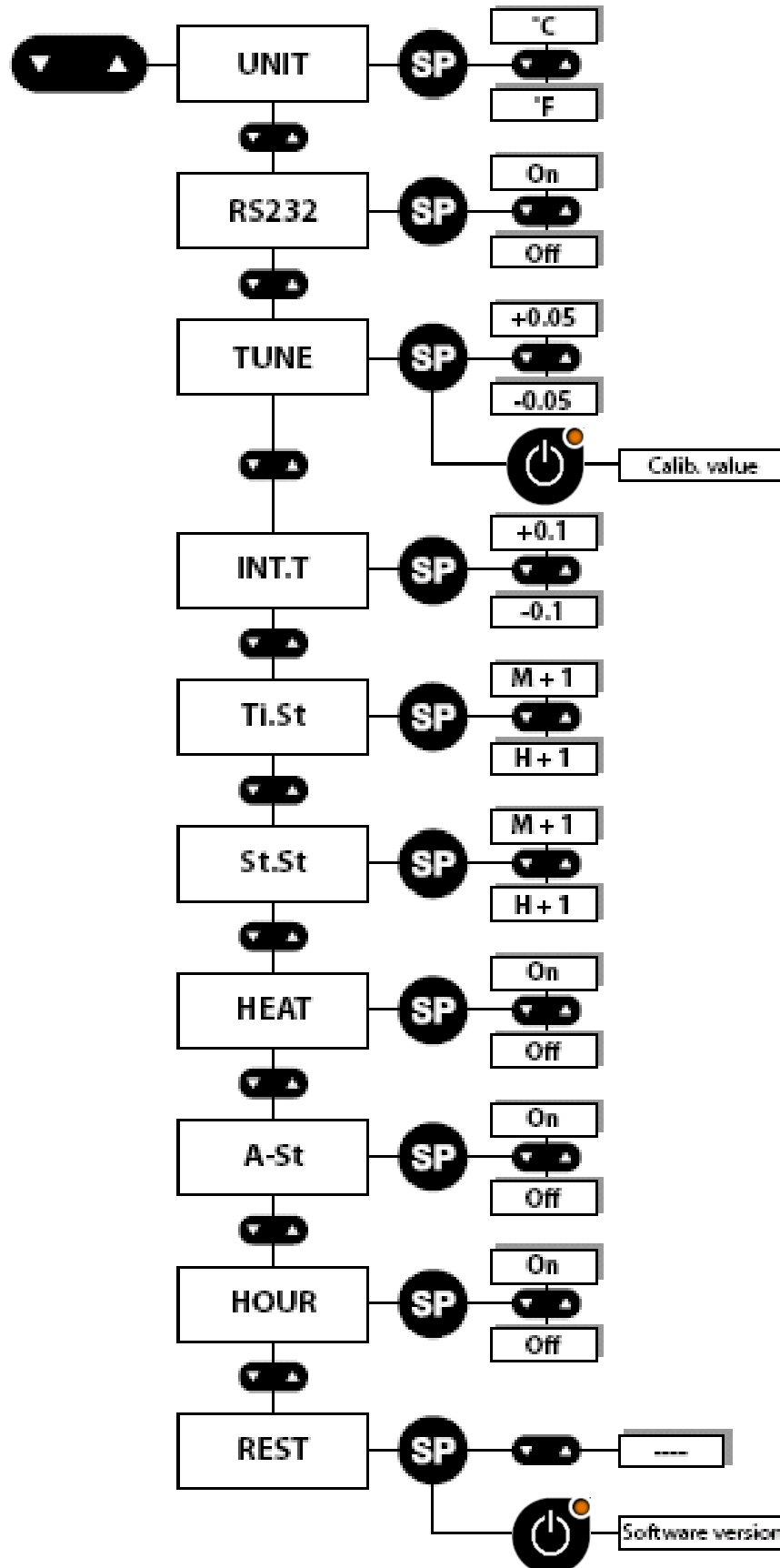





## Section 5

### Unit

In the UNIT option the **displayed temperature** unit can be set to either degrees **Celsius** or **Fahrenheit**.

Follow these steps to navigate in the UNIT option.







Action	Key	Display
Press and hold UP+DOWN key for 3 seconds to enter the menu. The menu "UNIT" will appear in the display.		
Press and hold set-point key to change values.		
While holding the set-point key in, press either the arrow UP or arrow DOWN key to select the required type of unit. When the required type has been selected let go of the set-point key.		
Press and hold UP+DOWN key for 3 seconds to exit the menu.		

5

**RS232**

The RS232 output was intended for data-logging and third-party monitoring, but is no longer supported by CSI. The steps below are provided for reference only.

Follow these steps to navigate in the RS232 option.

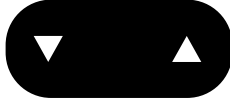
Action	Key	Display
Press and hold UP+DOWN key for 3 seconds to enter the menu. The option "UNIT" will appear in the display		
Press DOWN key until the option "RS232" appears in the display		
Press and hold set-point key to change values.		
While holding the set-point key in, press either the arrow UP or arrow DOWN key to select between "ON" and "OFF". "OFF": The RS232 function is turned off. "ON": Data is send once every two seconds. When the required setting is activated, let go of the set-point key		
Press and hold UP+DOWN key for 3 seconds to exit the menu.		

Data logging the temperature valves during use:

*Note: The RS232 cable must be connected before start.*

## Tune







The TUNE option is for **calibration** of the **displayed temperature**.

If there is an offset between the value on the display and any measurements made with a high precision external temperature sensor, this can be corrected.

The new temperature reading will be kept as the displayed value, with temperature control conducted on this basis.

Follow these steps to navigate in the TUNE option.

5

Action	Key	Display
Press and hold UP+DOWN key for 3 seconds to enter the menu. The menu "USER" will appear in the display.		
Press DOWN key until the option "TUNE" appears in the display.		
Press and hold set-point key to change values.		
While holding the set-point key in, press either the arrow UP or arrow DOWN key to select the value temperature. When the required setting is activated, let go of the set-point key.		
Press and hold UP+DOWN key for 3 seconds to exit the menu.		

*Note: Any change in the factory set calibration should always be based on very certain temperature measurements. CooperSurgical only recommends the use of a high quality PT-100 sensor that is calibrated with the precision instrument used for measuring according to the manufacturers specifications. Also ensure an optimal contact between the sensor and the place measured. Use only a sensor type that is correct for the purpose and of correct size. If in doubt contact your local CooperSurgical distributor.*

## INT.T

Should only be performed by an authorized K-System engineer. The INT.T (Integral Time) option is for changing the **base value** for the **PID controller**. If set at a different level the controlling principle will be affected. From the factory it is set to a closely calculated value specific for the model.









**CAUTION:** Do not change the value here. If by mistake any changes are made or doubts occur if the value are correct please set the REST function in the menu for the restore of the defaults.



**Ti.St**

The Ti.St (Time Set) option is for **setting the time**.

Follow these steps to navigate in the Ti.St option.

Action	Key	Display
Press and hold UP+DOWN key for 3 seconds to enter the menu. The option "UNIT" will appear in the display.		
Press DOWN key until the option "Ti.St." appears in the display.		
Press and hold set-point key to change values.		
While holding the set-point key in, press either the arrow UP to change minutes or arrow DOWN key to change the hour. When the time is set, let go of the set-point key.		
Press and hold UP+DOWN key for 3 seconds to exit the menu.		







## St.St

The St.St (Start Set) option is the **timer function** for the **heat**.

By using this option, time can be saved as the G73 can be ready for use before procedures start in the morning.

*Note: This function will only work correctly if the clock is set.*

Follow these steps to navigate in the St.St option.

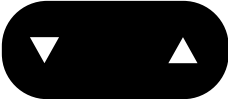
Action	Key	Display
Press and hold UP+DOWN key for 3 seconds to enter the menu. The menu "UNIT" will appear in the display.		
Press key DOWN until the option "St.St" appears in the display.		
Press and hold set-point key to change values.		
While holding the set-point key, press either the arrow UP to change minutes or arrow DOWN key to change the hour. When the time is set, let go of the set-point		
Press and hold UP+DOWN key for 3 seconds to exit the menu.		

*Note: If the function Heat is set, a dot will light up in the right side of display.*

St.St is connected with HEAT. It must be chosen when the timer starts. To turn the heater on, please see "Heat" on page 15.









**WARNING:** Always make sure when the timer function is being used, that the heated area is clear of any objects that might be damaged by the heat or adversely affected by it in way. Caution should always be exercised when a heated area is turned on without any supervision.

## Heat

The HEAT option is used for the heater to **turn on at a certain time**.

*Note: This function only works in conjunction with St.St. If St.St is set to 8.00 and heat function is on, the heater will automatically turn on at 8.00 using 24 hour clock.*

Follow these steps to navigate in the HEAT menu.







Action	Key	Display
Press and hold UP+DOWN key for 3 seconds to enter the menu. The first menu "UNIT" will appear in the display.		
Press DOWN key once and the menu "HEAT" appears in the display.		
Press and hold set-point key to change values.		
While holding the set-point key in, press either arrow UP or arrow DOWN key to select between "ON" and "OFF". When the required setting is activated, let go of the set-point key.		
Press and hold UP+DOWN key for 3 seconds to exit the menu.		

## A-ST

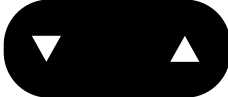
The A-St (Automatic Start) option is used to repeat the timer (St.St) function every day of the week.

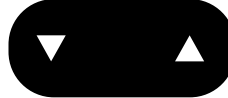
*Note: This function works in conjunction with St.St and HEAT. If St.St is set to 8.00 and heat function is on, the heater will automatically turn on at 8.00 every day.*

Follow these steps to navigate in the A-st option.







Action	Key	Display
Press and hold UP+DOWN key for 3 seconds to enter the menu. The first menu "UNIT" will appear in the display.		
Press DOWN key until the option "A-st" appears in the display.		
Press and hold set-point key to change values.		
While holding the set-point key in, press either arrow UP or arrow DOWN key to select between "ON" and "OFF". When the required setting is activated, let go of the set-point key.		
Press and hold UP+DOWN key for 3 seconds to exit the menu.		

*Note: If this function is set to 'on' the heat function will be repeated every day, But if A-St function is set to "off" the heat function will only be activated one time.*

## Hour



The HOUR option gives the opportunity to **show the time** on the display when the **heat is off**.

Follow these steps to navigate in the HOUR option.



Action	Key	Display
Press and hold UP+DOWN key for 3 seconds to enter the menu. The first menu "UNIT" will appear in the display.		
Press DOWN key until the option "HOUR" appears in the display.		
Press and hold set-point key to change values.		
While holding the set-point key in, press either arrow UP or arrow DOWN key to select between "ON" and "OFF". When the required setting is activated, let go of the set-point key.		
Press and hold UP+DOWN key for 3 seconds to exit the menu.		

5

If you want to see the time on the display when the heat is turned on. Follow these steps to switch between time and temperature.

Action	Key	Display
Press and hold set-point key.		
While holding the set-point key in, press the HEAT key one time, then let go of the set-point key. The display now shows the time.		

To change back to temperature.

Action	Key	Display
Press and hold set-point key.		
Press the HEAT key one time, then let go of the set-point key. The display now shows the temperature.		

*Note: The time is shown as a 24 hour clock e.g. 19.30 not 7.30PM.*









## Rest

The REST function will **restore all factory set values**.

Any changes made to the displayed temperature, unit readings and controller value will be reset.

*Note: Calibration value in the TUNE option will remain and not be reset.*

Follow these steps to navigate in the REST option.

Action	Key	Display
Press and hold UP+DOWN key for 3 seconds to enter the menu. The first menu "UNIT" will appear in the display.		
Press DOWN key until the option "REST" appears in the display.		
Press and hold set-point key to change values.		
While holding the set-point key in, press either the arrow UP or arrow DOWN key. When the display shows "----", *let go of the set-point key.		
Press and hold UP+DOWN key for 3 seconds to exit the menu.		

*\*This means all factory values have now been restored.*

5

## SECTION 6 - CARE AND MAINTENANCE

### Cleaning

Periodic cleaning is recommended as part of routine maintenance. Disinfection is also recommended for media spills, visual accumulation of dust, and other evidence of contamination.

Clean and disinfect the surfaces when necessary and immediately after any media spills.

Cleaning and disinfection should be performed with the equipment switched off.

Gloves should be worn during cleaning, disinfecting and sterilizing.

### Preparation at the Point of Use

After every patient procedure, wipe down the surfaces immediately after use to prevent soil from drying on the device by performing the following steps:

1. Moisten a clean lint-free cloth with warm tap water (38°C to 49°C)
2. Use the moistened clean, lint-free cloth and wipe off any visual soil.

### Periodic Cleaning

1. Apply a laboratory detergent evenly to all surfaces.
2. Moisten a sterile non-linting cloth with purified or sterile water and wipe all surfaces. If needed, use additional cloths if cloths become visibly soiled.
3. Allow to air dry.
4. Visually inspect for the absence or presence of remaining soil. While inspecting, give particular attention to verifying soil has been removed from the hard-to-clean areas. If soil is present, then repeat the manual cleaning steps until all visible soil is removed.

### Disinfection

After the surface is clean and all visual soil has been removed, proceed with the following instructions to disinfect the surfaces as follows:

1. Apply evenly to all surfaces using laboratory disinfectant spray. Wait a minimum of 15 minutes for the surfaces to dry for best results.
2. Moisten a sterile non-linting cloth with purified or sterile water and wipe all disinfected surfaces for a minimum of one (1) minute.

### Drying

Thoroughly dry all surfaces using a sterile, lint-free wipe or cloth, changing wipes/ cloths when necessary to ensure the surfaces are completely dry. Visually inspect the surfaces to ensure all surfaces are clean and dry. Repeating drying steps if any moisture is visible.

*Note: If water gets inside the equipment, contact your CooperSurgical representative to check electrical safety.*

### Calibration

For optimal performance the unit should be calibrated once a year by authorized CooperSurgical Service provider.

### Disposal of electrical and electronic equipment.

CooperSurgical have taken the necessary steps to comply with the EC directive 2012/19/EU on waste electrical and electronic equipment (WEEE).



**Environmental implications:** WEEE contains materials that are potentially hazardous to the environment and to human health. Therefore, when this instrument has reached its end of life it must be collected and recycled separately from other waste according to national requirements. Please contact a local CooperSurgical distributor for instructions. Do not dispose of with 'normal' waste.



**SECTION 7 - TROUBLESHOOTING**

<b>Symptom</b>	<b>Cause</b>	<b>Action</b>
Temperature alarm is on.	Temperature more than $\pm 0.5^{\circ}\text{C}$ from set temperature.	Check the set temperature. Wait for the temperature to stabilize.
No heating.	Set-point below ambient.	Change set-point (e.g. $37^{\circ}\text{C}$ ).
Display remains off when "HEAT" key is activated.	No mains supply.	Plug in the power connector.
	Power connector, not connected.	Reconnect power connector.
	Defective "HEAT" key.	Replace the keyboard.

## SECTION 8 - TECHNICAL DATA

<b>Material</b>	Stainless steel
<b>Weight (without PSU and BLOCK)</b>	1.66kg
<b>Overall dimensions (WxDxH)</b>	200x178x95mm
<b>Warmed surface area</b>	51x115mm
<b>Temperature range</b>	Ambient to 49.9°C
<b>Spot temperature accuracy</b>	±0.2°C
<b>Temperature set/read</b>	Digital LED display
<b>Power consumption</b>	25W
<b>Heating</b>	20W
<b>PSU</b>	AC input 100-240V 50-60Hz 1.6A MAX DC output 24V/5A
<b>Alarms</b>	Audible and visible for out of range temperature

## SECTION 9 - WARRANTY INFORMATION AND LIMITS ON LIABILITY

CooperSurgical, Inc. warrants the operational safety and correct system operation of the whole unit under the condition that:

- The device is operated as described in the manuals
- The device has not been modified
- All service intervals are kept according to manuals
- Only original spare parts and accessories that have been approved by CooperSurgical are used

CooperSurgical warrants that the G73 will be free from defects in materials and workmanship for one year from the date of initial purchase. If CooperSurgical determines that a workstation fails to conform to that warranty during the one-year warranty period, CooperSurgical will, as the sole remedy for that failure to conform, repair or replace that workstation, at CooperSurgical's discretion, free of charge.

To return a workstation to CooperSurgical, a customer must comply with CooperSurgical's Returned Goods Policy described in this manual. A customer will not have any remedy if a workstation does not conform to the warranty for that workstation unless that workstation is returned to CooperSurgical in accordance with that Returned Goods Policy. CooperSurgical will ship returned products that it repaired or replaced under warranty to the customer who returned those products, at CooperSurgical's expense F.O.B. the customer's facility. Under all other circumstances, CooperSurgical will ship returned products to the customer who returned those products at the customer's expense F.O.B. CooperSurgical's facility.

CooperSurgical's warranties do not cover damage caused by misuse, improper care, improper use of chemicals or cleaning methods, loss, theft, servicing by non-authorized personnel or negligent or intentional conduct on the part of the owner or user of the workstation, nor do they cover normal wear and tear or general maintenance. Any modifications or changes to a workstation will void that workstation's warranty. CooperSurgical's warranties do not apply to any single- or limited-use, disposable or consumable components or items.

CooperSurgical is not responsible for, and the owner and operator of the workstation shall defend, indemnify and hold harmless CooperSurgical from and against, any claims, damages, and other losses resulting from the improper servicing, maintenance, repair use or operation of the workstation or the owner or operator's negligence or willful misconduct.

COOPERSURGICAL SHALL NOT UNDER ANY CIRCUMSTANCES BE LIABLE FOR LOST PROFITS, DAMAGES FROM LOSS OF USE OR LOST DATA, OR INDIRECT, SPECIAL, INCIDENTAL OR CONSEQUENTIAL DAMAGES UNDER ITS WARRANTIES OR OTHERWISE FOR ANY CLAIM RELATED TO COOPERSURGICAL'S PRODUCTS, EVEN IF COOPERSURGICAL HAS BEEN ADVISED, KNEW OR SHOULD HAVE KNOWN OF THE POSSIBILITY OF SUCH DAMAGES. COOPERSURGICAL'S LIABILITY WITH RESPECT TO A PRODUCT COVERED BY A WARRANTY OR OTHERWISE SHALL BE LIMITED IN ALL CIRCUMSTANCES TO THE PURCHASE PRICE OF THAT PRODUCT. THE ABOVE WARRANTIES ARE IN LIEU OF, AND COOPERSURGICAL HEREBY DISCLAIMS, ALL OTHER WARRANTIES, EXPRESS OR IMPLIED, WRITTEN OR ORAL, WITH RESPECT TO COOPERSURGICAL'S PRODUCTS, INCLUDING THE WARRANTIES OF MERCHANTABILITY AND FITNESS FOR A PARTICULAR PURPOSE. NO TERMS, CONDITIONS, UNDERSTANDINGS OR AGREEMENTS THAT PURPORT TO MODIFY THE ABOVE WARRANTIES OR THAT MAKE ANY ADDITIONAL WARRANTIES FOR ANY COOPERSURGICAL PRODUCT SHALL HAVE ANY LEGAL EFFECT UNLESS MADE IN WRITING AND SIGNED BY AN AUTHORIZED COOPERSURGICAL CORPORATE OFFICER.

### SECTION 10 - RETURNING PRODUCT

Please refer to the 'Troubleshooting' section in this manual before returning product to CSI. If the problem continues, please follow these instructions:

#### Returned Goods Policy

Goods will be accepted for return for the following reasons:

- If shipment was made without the customer's authorization or order.
- If incorrect items were shipped.
- If defective items were shipped.
- If defective goods are covered by the standard warranty.

To return product, contact Customer Service for a Returned Merchandise Authorization (RMA) number. Items will not be accepted without an RMA number. Please have the following information:

- Reason for returning the goods.
- Quantity, description, part number, serial number of the goods.
- Date of receipt of order.
- Customer's purchase order and the CSI or Origio invoice number.

All used products must be cleaned and sterilized prior to shipment. A signed decontamination declaration may be required.

All products should be carefully and adequately packed, preferably in original packaging. Replacement items or additional repairs will be invoiced.

All packaging should be clearly labeled with the RMA number and statement "Urgent – Returned Items for Repair".

Return Address: Research Instruments Ltd, Bickland Industrial Park, Falmouth, Cornwall, TR11 4TA, UK.

Shipment must be sent prepaid by the customer and insured for their full value during shipping. Freight collect shipments will not be accepted, and goods will be returned to sender.

If Customer intends to return equipment ordered in error, the following restocking charges and terms will apply:

- 25 percent within 60 days from date of shipment.
- Goods must be returned unused, in the original carton, and in marketable condition.
- Refurbishing and replacement charges will be added to the restocking charges for damaged or missing items.
- No return after 60 days.
- No refund on sterile, single-use disposable products.

**Customer Service Contact Details:**

Tel: +45 46 79 02 02

Fax: +45 46 79 03 02

E-mail: [sales@coopersurgical.com](mailto:sales@coopersurgical.com)

[fertility.coopersurgical.com](http://fertility.coopersurgical.com)

**US Only Customers Contact Details:**

Tel: 800-243-2974

Fax: 800-262-0105

[fertility.coopersurgical.com](http://fertility.coopersurgical.com)

## SECTION 11 - CUSTOMER SERVICE CONTACT INFORMATION

### European Service Representatives

ORIGIO a/s  
Knardrupvej 2  
2760 Måløv  
Denmark  
Tel: +45 46 79 02 02  
Fax: +45 46 79 03 02

#### **New Purchases:**

E-mail: [sales@coopersurgical.com](mailto:sales@coopersurgical.com)

#### **Service Related E-mail:**

[service@coopersurgical.com](mailto:service@coopersurgical.com)  
[fertility.coopersurgical.com](mailto:fertility.coopersurgical.com)

### US Service Representatives

CooperSurgical, Inc.  
95 Corporate Drive  
Trumbull, CT 06611 USA  
Phone: 800-243-2974  
Fax: 800-262-0105  
International Phone: +1 (203) 601-9810  
Fax: +1 203 601-4747

#### **Service Related E-mail:**

[serviceandrepair@coopersurgical.com](mailto:serviceandrepair@coopersurgical.com)  
[fertility.coopersurgical.com](mailto:fertility.coopersurgical.com)



