

CE

K-Systems™ G85 Mini Incubator

User Manual



K22074 Version 3.0

Contents

1	General information & service	3
2	Symbols glossary	4
3	Unpacking and inspection	5
4	Parts supplied with incubator	5
	4.1 Standard accessories.....	5
	4.2 Optional accessories.....	6
5	User manual	7
	5.1 Intended purpose	7
	5.2 Product description.....	7
6	Features and operation	8
	6.1 Set up of apparatus	8
	6.2 Keyboard functions.....	9
	6.3 Operating the heated compartment.....	10
	6.4 Temperature setting and control	10
	6.5 Combination keys.....	10
	6.6 Gas flow setting.....	11
	6.6.1 Why gassing?.....	11
	6.6.2 Working gas pressure	11
	6.6.3 Humidifying the gas mixture	12
	6.6.4 Purge function.....	13
	6.7 Temperature/Flow alarm	14
	6.7.1 Temperature alarm.....	14
	6.7.2 Gas flow alarm	14
	6.8 Warming up.....	15
7	Menu function	16
	7.1 Overview of options.....	17
	7.2 UNIT.....	18
	7.3 RS232	19
	7.4 TUNE	20
	7.5 Integral Time (INT.T).....	21
	7.8 HEAT.....	23
	7.9 Automatic Start (A-ST).....	24
	7.10 HOUR 25	
	7.11 REST 26	
8	User maintenance	27
	8.1 Cleaning	27
	8.2 Calibration.....	27
9	Trouble shooting	28
10	Technical data	29
11	Disposal and recycling	29
12	Warranty information and limits on liability	30
13	Customer service contact details	32

1 General information & service

This manual is protected by copyright, all rights reserved, and no part hereof may be photocopied or reproduced in any form without the prior written, consent of CooperSurgical, Inc.

Users of CooperSurgical K-SYSTEMS™ products should not hesitate to contact us if there are any unclear points or ambiguities in this manual.

CooperSurgical, Inc.
95 Corporate Drive
Trumbull, CT 06611, USA

Tel: +45 46 79 02 02
Fax: +45 46 79 03 02
sales@coopersurgical.com
fertility.coopersurgical.com

Contact Details for Customers in the USA













Tel: 800-243-2974
Fax: 800-262-0105
fertility.coopersurgical.com

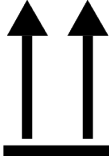

CAUTION: If the equipment is used in a manner not specified by this manual, the safety of the user may be at risk and the equipment may be damaged. Always use the equipment as outlined in this instruction manual.

2 Symbols glossary

Source: ISO 15223-1



Symbol	Meaning	Symbol	Meaning
	In accordance with Low Voltage Directive 2014-35-EU		Do not dispose of product with normal waste. Dispose of in accordance with the EU WEEE Directive
	Serial number		Consult instructions for use
	Catalogue number		This way up
	Manufacturer		Stacking limited to 3 units
	Country of manufacture		Fragile, handle with care
	Date of manufacture		
	WARNING: Indicates a potentially hazardous situation which, if not avoided, could result in serious injury or death		Keep dry
	CAUTION: Indicates a potentially hazardous situation which, if not avoided, could result in minor or moderate injury		

3 Unpacking and inspection

- Unpack the equipment.
- Check the packing list to ensure all accessories are there.
- Examine the packing material carefully for separately packed items.
- Check the incubator for external surface damage.
- Check that the display is not broken or damaged.
- Check that the lids and gas flow regulator knob operate correctly without any hindrance.

4 Parts supplied with incubator

4.1 Standard accessories

<p>24V mains adapter (PSU)</p> <p>Order code: 51122</p>	
<p>Mains Cable</p> <p>Standard Schuko – Oder code: 52768 UK – Order code: 53886 US – Order code: 52773</p>	
<p>Silicone tube</p> <p>Order code: 11066</p>	

4.2 Optional accessories

The following warming blocks can be purchased for use with the incubator.

<p>Warming block B16 Holds two culture dishes</p> <p>B16F – Falcon 353001 Order code:26059</p> <p>B16N – NUNC 150318 Order code: 26060</p>	
<p>Warming block B24 Holds one center well dish</p> <p>Falcon 353653</p> <p>Order code: 26027</p>	
<p>Warming block B25 Holds one 60 mm culture dish</p> <p>Falcon 353002 NUNC 150288</p> <p>Order code: 26028</p>	
<p>Warming block B26 Holds one 4-well Falcon dish with lid</p> <p>Falcon 353654</p> <p>Order code: 26031</p>	
<p>Warming block B28 Holds one 4-well dish</p> <p>NUNC 176740</p> <p>Order code: 26029</p>	
<p>Warming block B29 Holds one 5-well dish</p> <p>MiniTüb 19021/0005</p> <p>Order code: 26030</p>	

5 User manual

5.1 Intended purpose

The CooperSurgical K-Systems G85 Mini Incubator is designed for keeping gametes and embryos in a controlled environment.

5.2 Product description

The chambers and aluminum warming blocks maintain a preset temperature in the range ambient to 42°C. The temperature on the display in increments is electronically controlled by a PID controller and can be read on the displaying in increments of 0.1°C.

The G85 features heated lids. The bottom part is made from thick aluminum that gives ideal temperature distribution. Interchangeable aluminum warming blocks holding a variety of culture dishes are available.

The G85 features a built-in digital flow meter with a possible flow of 0 - 29 liters per hour and a humidification system.

The G85 has also a purge function enabling a quick CO₂ level recovery within the chambers. The recovery time is 15 seconds with a pressure of 0.5 bar.

Note: *The atmosphere in the chambers may be controlled by flushing with a gas mixture. Use only 5% CO₂ in air.*

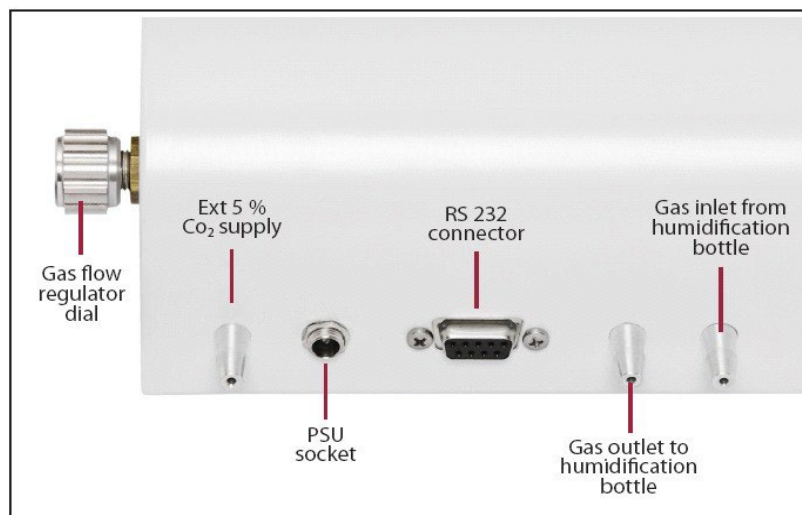

6 Features and operation

6.1 Set up of apparatus







Connect the unit to the PSU and the PSU to the mains wall socket.

To power up the unit, press the heat on button on the keyboard. The display will indicate the current temperature.

Adjust the gas flow with the control knob on the right-hand side of the unit. The valve controlling the flow is a precision valve with a short span from closed to open, so adjust with slow movements. A hint for adjusting is to close it fully and then open it gently.





6.2 Keyboard functions

	
Purge	
Heat ON/Off	
LED Display	
Setpoint	
Arrow keys UP/DOWN	
Alarm	

6.3 Operating the heated compartment







Action	Key	Display
Press heat ON/OFF key to show the actual temperature.		

6.4 Temperature setting and control

Action	Key
Press setpoint key and the set temperature is shown.	
Press and hold setpoint key.	
While holding the setpoint key in, press either the arrow UP or arrow DOWN key to raise or lower the set temperature. When the desired temperature is reached, let go of the setpoint key.	

Note: The setpoint can be adjusted to a reading between ambient and 49.9 °C.

6.5 Combination keys

Action	Key	Display
Press alarm and UP key.	 + 	The keyboard is locked.
Press alarm and UP key.	 + 	The keyboard is unlocked.
Press Heat ON/OFF and setpoint key.	 + 	Switches between temperature and time.

6.6 Gas flow setting

The display can switch between temperature and flow rate.

The flow rate is shown in the display by the integrated digital flow meter in the G85.

Action	Key
Press arrow key either up or down one time. Now the flow rate in liter per hour will be shown.	

The flow rate can be adjusted between 0 – 29 l/h.

If the flow becomes larger than 29 l/h the display will indicate “Hi”.

Action	Key
Press arrow key either up or down once again to change to the display of temperature.	

6.6.1 Why gassing?

Most of the culture media which are used in assisted reproduction techniques are sensitive to changes in pH. Culture media must be maintained at a pH about 7.4. This can be obtained by gassing with atmosphere of 5% or 6% CO₂. Refer to culture media instructions for use for any humidification requirements.

6.6.2 Working gas pressure

Working gas pressure (inlet pressure on the G85) must be regulated to 0.5 bar by a reduction valve. The reduction valve must be a high-quality unit of the pressure type that can be adjusted precisely in the 0-1 bar range.

The flow rate on the G85 must be adjusted to a specific level in accordance with the use of the unit.

Frequent openings of the lids will require higher flow rates.

Note: *Any use of flow type regulators or inadequate quality pressure type regulators will cause the flow on the G85 to be unstable and drift.*

Below is listed the full recovery rates for CO₂ level in both chambers in minutes.

This can be used as guideline for the use.

Flow (l/h)	*	10	28	50
Time (min)	**	12	2.8	0.9

*Flow setting in display of G85.

**Time it will take to recover CO₂ level after a chamber has been opened at the above flow setting.

If the use necessitates low recovery times, either a constant high flow must be used or purging the chambers by setting the flow level at a high rate for 2-3 minutes.

A flow of 10 l/h will be sufficient to sustain the CO₂ levels in the chambers when the lids are not opened. The flow rate should at no time be kept under 8 l/h.

A flow rate of 15-20 l/h should be adequate under most conditions without the use of manual purge.

6.6.3 Humidifying the gas mixture

In order to avoid gassing with cold and dry gas, the built in humidifier can be used.

Connect the tubes as shown on the picture below.

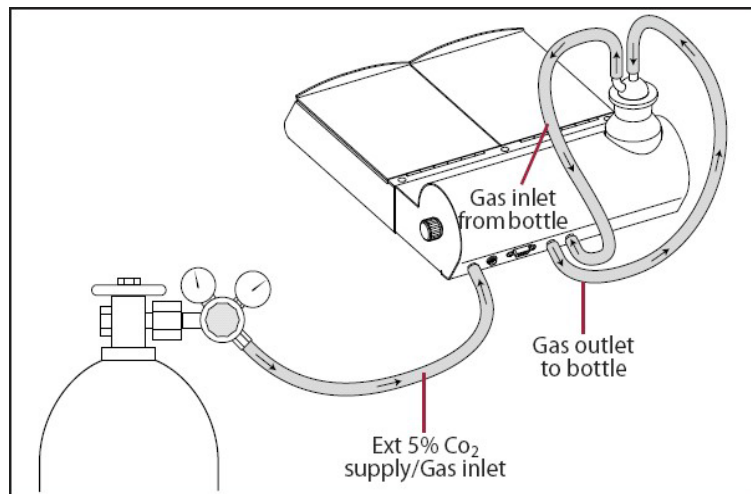

WARNING: Always route the gas as shown or permanent damage to the airflow sensors may occur.

If the humidification system is not used and the gassing is done with dry gas, a silicone tube U loop must be connected between the outlet and inlet for the humidification bottle.



CAUTION: The flow sensor may be damaged by water ingress from the humidification bottle.

The fault is registered by the user getting a “0” reading in the display when an obvious flow can be seen as bubbles in the humidification flask.

When adjustment in the flow rate is done on the regulator valve on the side of the G85, no changes can be seen to the flow reading in the display. It will stay at “0” disregarding the flow.

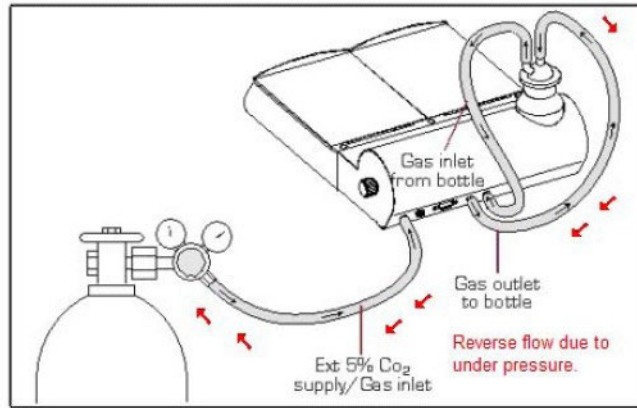

The fault occurs because of under pressure in the gas supply when the G85 is not in use.

If the user shuts off the gas supply only on the bottle or the external regulator an under pressure will develop. The under pressure will draw back liquid from the humidification bottle through the gas outlet to bottle tube and into the G85 where it will damage the flow sensor.

If the user remembers to completely close the regulator valve on the side of the G85 no such problem will occur.

- Alternatively, the exterior 5% CO₂ supply tube should be disconnected from the G85 when the G85 is not in use.

Or:

- The gas outlet to bottle tube disconnected when the G85 is not in use.

If the problem has occurred, the gas flow sensor PCB will need to be replaced.

6.6.4 Purge function

The G85 has a purge function enabling to have a fast recovery of the CO₂ level within the chambers. This function is to be used when the lid of the chambers has been opened in order to place or remove culture dishes. The purge time is 15 seconds.

Action	Key
Press the alarm key to activate the purge function.	
When activated a "Pu" indication appears on the display.	

6.7 Temperature/Flow alarm

The G85 has one alarm which is activated on two events:





- Temperature deviations (high or low)
- Gas flow

6.7.1 Temperature alarm

The temperature alarm indicates too high or too low temperature.

The alarm will be activated if the temperature rises or falls more than 0.5°C from the setpoint.

There will be an acoustic signal and the red LED light in the alarm key will be activated.

Action	Key
Press setpoint key and alarm key to mute the acoustic signal.	 + 
Press setpoint key and alarm key once again to bring the signal back on.	 + 

Note: *The red LED and the acoustic signal will turn off if the temperature or gas flow stabilizes again to the setpoint level.*

6.7.2 Gas flow alarm

The gas flow alarm will be activated if the flow is higher than 29 l/h. The display will then show “hi”.

The alarm will also be activated if the flow is “on”, and the heat “off”.

In this case the display will show “f.on”.

Note: *The maximum flow is 29 l/h. The G85 will not be damaged by a higher flow as long as the gas flow is kept below 100 l/h.*

6.8 Warming up

Warming up from 20.0°C to setpoint takes less than 30 minutes, under normal conditions.

When a cold item is placed in either of the chambers it may need up to 40 minutes to stabilize, depending on the thermal mass of the object and the initial temperature.



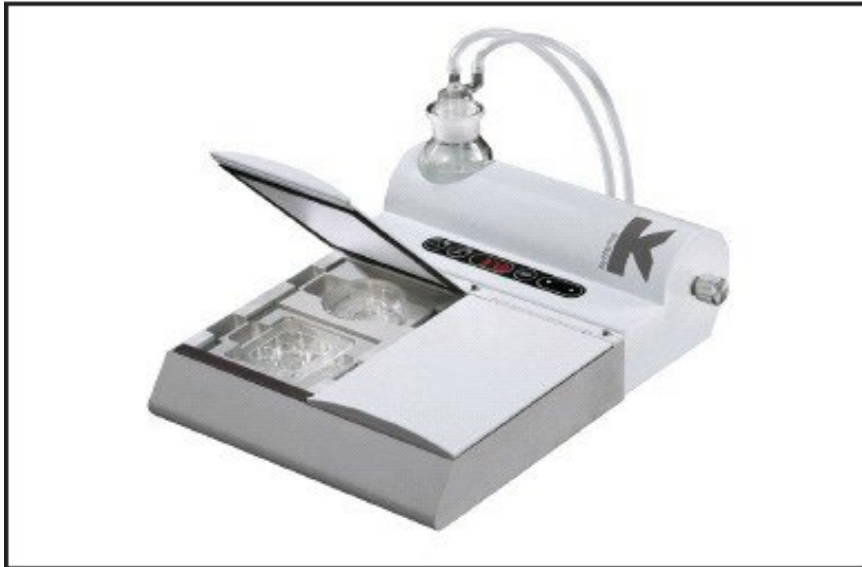

G85 with two warming blocks in one chamber and humidifier is shown on the picture below.



Note: *Always place a warming block in the chambers during warm up and be careful with the heated area under the humidifier bottle as it will become hot.*

7 Menu function

The user can access a number of advanced functions via the menu.

Action	Key	Display
Press and hold UP+DOWN key for 3 seconds to enter the menu. The first option "UNIT" will appear in the display.		
Press UP/DOWN key to navigate within the Menu.		
While holding the setpoint key in, press either the arrow UP or arrow DOWN key to change values within the options.		
Press and hold UP+DOWN key for 3 seconds again to exit the menu.		

The menu consists of the 10 options listed below.
For further detail see the description on the following pages.



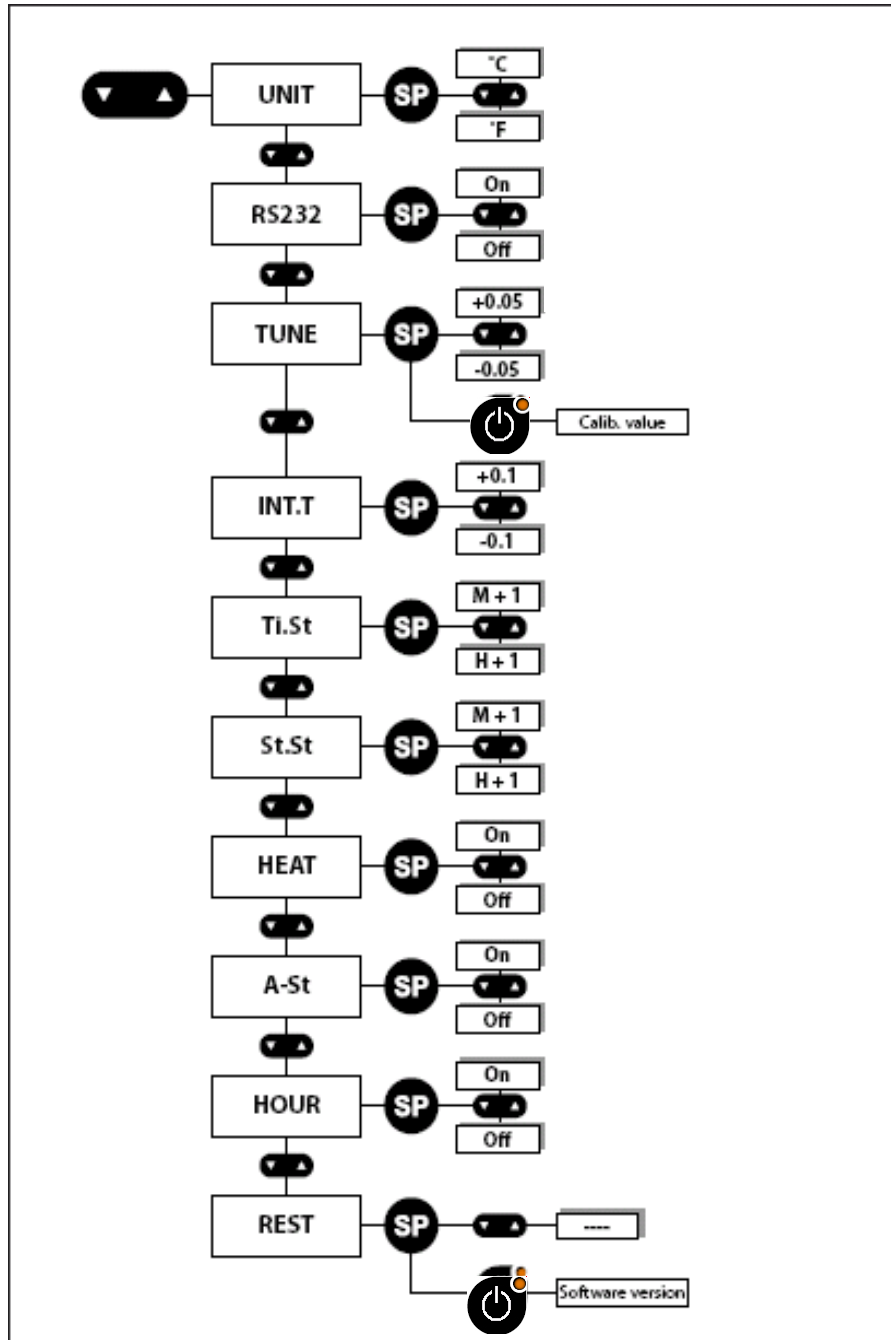

7.1 Overview of options



7.2 UNIT

In the UNIT option the **displayed temperature** unit can be set to either degrees **Celsius** or **Fahrenheit**.







Follow these steps to navigate in the UNIT option.

Action	Key	Display
Press and hold UP+DOWN key for 3 seconds to enter the menu. The menu "UNIT" will appear in the display.		
Press and hold setpoint key to change values.		
While holding the setpoint key in, press either the arrow UP or arrow DOWN key to select the required type of unit. When the required type has been selected let go of the setpoint key.		
Press and hold UP+DOWN key for 3 seconds to exit the menu.		

7.3 RS232

The RS232 option is for serial communication and data logging of the **temperature and alarm conditions**.

Follow these steps to navigate in the RS232 option.

Action	Key	Display
Press and hold UP+DOWN key for 3 seconds to enter the menu. The option "UNIT" will appear in the display.		
Press DOWN key until the option "RS232" appears in the display.		
Press and hold setpoint key to change values.		
While holding the setpoint key in, press either the arrow UP or arrow DOWN key to select between "ON" and "OFF". "OFF": The RS232 function is turned off. "ON": Data is sent once every two seconds. When the required setting is activated, let go of the setpoint key.		
Press and hold UP+DOWN key for 3 seconds to exit the menu.		

Data logging the temperature valves during use.

Note: *RS232 communication is no longer supported.*







7.4 TUNE

The TUNE option is for **calibration** of the **displayed temperature**.

If there is an offset between the value on the display and any measurements made with a high precision external temperature sensor, this can be corrected.

The new temperature reading will be kept as the displayed value, with temperature control conducted on this basis.

Follow these steps to navigate in the TUNE option.

Action	Key	Display
Press and hold UP+DOWN key for 3 seconds to enter the menu. The menu "USER" will appear in the display.		
Press DOWN key until the option "TUNE" appears in the display.		
Press and hold setpoint key to change values.		
While holding the setpoint key in, press either the arrow UP or arrow DOWN key to select the value temperature. When the required setting is activated, let go of the setpoint key.		
Press and hold UP+DOWN key for 3 seconds to exit the menu.		

Note: *Any change in the factory set calibration should always be based on very certain temperature measurements. CooperSurgical only recommend the use of a high-quality PT-100 sensor that is calibrated with the precision instrument used for measuring according to the manufacturers specifications. Also ensure an optimal contact between the sensor and the place measured. Use only a sensor type that is correct for the purpose and of correct size. If in doubt, contact your local distributor or CooperSurgical.*

7.5 Integral Time (INT.T)

The INT.T (Integral Time) option is for changing the **base value** for the **PID controller**. This should not be attempted by unauthorized persons. If set at a different level the controlling principle will be affected.

From the factory it is set to a closely calculated value specific for the model.



CAUTION: *Do not change the value here. If by mistake any changes are made or doubts occur if the value are correct, please set the REST function in the menu for the restore of the defaults.*

7.6 Time Set (Ti.St)

The Ti.St (Time Set) option is for **setting the time**.

Follow these steps to navigate in the Ti.St option.







Action	Key	Display
Press and hold UP+DOWN key for 3 seconds to enter the menu. The option "UNIT" will appear in the display.		
Press DOWN key until the option "Ti.St." appears in the display.		
Press and hold setpoint key to change values.		
While holding the setpoint key in, press either the arrow UP to change minutes or arrow DOWN key to change the hour.		
Press and hold UP+DOWN key for 3 seconds to exit the menu.		

7.7 Start Set (St.St)

The St.St (Start Set) option is the **timer function** for the **heat**. By using this option, time can be saved as the G85 can be ready for use before procedures start in the morning.

Note: *This function will only work correctly if the clock is set.*

Follow these steps to navigate in the St.St option.

Action	Key	Display
Press and hold UP+DOWN key for 3 seconds to enter the menu. The menu "UNIT" will appear in the display.		
Press key DOWN until the option "St.St" appears in the display.		
Press and hold setpoint key to change values.		
While holding the setpoint key, press either the arrow UP to change minutes or arrow DOWN key to change the hour. When the time is set, let go of the setpoint		
Press and hold UP+DOWN key for 3 seconds to exit the menu.		

Note: *If the function Heat is set, a dot will light up in the right side of display.*

St.St is connected with HEAT. It must be chosen when the timer starts. To turn the heater on, please see section 7.8.









WARNING: Always make sure when the timer function is being used, that the heated area is clear of any objects that might be damaged by the heat or adversely affected by it in way. Caution should always be exercised when a heated area is turned on without any supervision.

7.8 HEAT

The HEAT option is used for the heater to **turn on at a certain time**.

Note: *This function only works in conjunction with St.St.
If St.St is set to 8.00 and heat function is on, the heater will automatically turn on at 8.00 using 24 hour clock.*

Follow these steps to navigate in the HEAT menu.

Action	Key	Display
Press and hold UP+DOWN key for 3 seconds to enter the menu. The first menu "UNIT" will appear in the display.		
Press DOWN key once and the menu "HEAT" appears in the display.		
Press and hold setpoint key to change values.		
While holding the setpoint key in, press either arrow UP or arrow DOWN key to select between "ON" and "OFF". When the required setting is activated, let go of the setpoint key.		
Press and hold UP+DOWN key for 3 seconds to exit the menu.		







Note: *A dot will turn on in the right side of display, indicating that the Heat function is active.*

7.9 Automatic Start (A-ST)

The A-St (Automatic Start) option is used to **repeat the timer (St.St) function every day of the week.**

Note: *This function works in conjunction with St.St and HEAT.
If St.St is set to 8.00 and heat function is on, the heater will automatically turn on at 8.00 every day.*

Follow these steps to navigate in the A-st option.







Action	Key	Display
Press and hold UP+DOWN key for 3 seconds to enter the menu. The option "UNIT" will appear in the display.		
Press DOWN key until the option "A-st" appears in the display.		
Press and hold setpoint key to change values.		
While holding the setpoint key in, press either arrow UP or arrow DOWN key to select between "ON" and "OFF". When the required setting is activated, let go of the setpoint key.		
Press and hold UP+DOWN key for 3 seconds to exit the menu.		

Note: *If this function is set to 'on' the heat function will be repeated every day, but if A-St function is set to "off" the heat function will only be activated one time.*



7.10 HOUR

The HOUR option gives the opportunity to **show the time** on the display when the **heat is off**.



Follow these steps to navigate in the HOUR option.

Action	Key	Display
Press and hold UP+DOWN key for 3 seconds to enter the menu. The option "UNIT will appear in the display.		
Press DOWN key until the option "HOUR" appears in the display.		
Press and hold setpoint key to change values.		
While holding the setpoint key in, press the arrow UP or arrow DOWN key to select between "ON" and "OFF". When the required setting is activated, let go of the setpoint key.		
Press and hold UP+DOWN key for 3 seconds to exit the menu.		

If you want to see the time on the display when the heat is turned on. Follow these steps to switch between time and temperature.

Action	Key	Display
Press and hold setpoint key.		
While holding the setpoint key in, press the HEAT key one time, then let go of the setpoint key. The display now shows the time.		

To change back to temperature.

Action	Key	Display
Press and hold setpoint key.		
Press the HEAT key one time, then let go of the setpoint key. The display now shows the temperature.		

Note: The time is shown as a 24-hour clock e.g. 19.30 not 7.30 PM.









7.11 REST

The REST function will **restore all factory set values**.

Any changes made to the displayed temperature, unit readings and controller value will be reset.

Note: Calibration value in the TUNE option will remain and not be reset.

Follow these steps to navigate in the REST option.

Action	Key	Display
Press and hold UP+DOWN key for 3 seconds to enter the menu. The option "UNIT" will appear in the display.		
Press DOWN key until the option "REST" appears in the display.		
Press and hold the setpoint key to change values.		
While holding the setpoint key in, press either the arrow UP or arrow DOWN key. When the display shows "----", *let go of the setpoint key.		
Press and hold UP+DOWN key for 3 seconds to exit the menu.		

*This means all factory values have now been restored.

8 User maintenance

8.1 Cleaning

The G85 can be wiped clean with a sterile cloth moist with sterile water.

Moisten a cloth with cleaning solution, and wipe all internal surfaces of the chamber. Thereafter wipe all cleaned surfaces with a sterile cloth moist with purified or sterile water. Following cleaning, leave lids open to allow sufficient time to ensure that all surfaces are dry.

Humidification bottle can be put in an autoclave.

8.2 Calibration

For optimal performance the unit should be calibrated annually by an authorized CooperSurgical K-Systems service provider.

9 Trouble shooting

Symptom	Cause	Action
Temperature alarm is on.	Temperature more than $\pm 0.5^{\circ}\text{C}$ from set temperature.	Check the set temperature. Wait for the temperature to stabilize.
No heating.	Setpoint below ambient.	Change setpoint (eg. 37°C).
Display remains off when "HEAT" key is activated.	No mains supply.	Plug in the power connector.
	Power connector, not connected.	Reconnect power connector.
	Defective "HEAT" key.	Replace the keyboard.
Flow alarm is on slow acoustic signal sounds and the display shows "-hi-".	The flow is higher than 29 l/h.	Reduce the flow.
Flow alarm is on. Fast acoustic signal sounds and display shows "f.on".	The flow is on and the heat is off	Turn the flow off.

10 Technical data

Material	Stainless steel (upper parts) Aluminum (lower parts)
Weight (without PSU and BLOCK)	5.4kg
Overall dimensions (WxDxH)	267x340x95mm
Temperature range	Ambient to 42°C
Spot temperature accuracy	± 0.2°C
Flow range	0 – 29 liters/hour
Power consumption	120W
Heating	100W
Gas consumption	0 – 29 liters/hour
Gas inlet pressure	0.3 – 0.5 Bar
PSU	AC input 100-240V 50-60Hz 1.6A MAX DC output 24V/5A
Alarms	Audible and visible for out of range temperature and air flow

11 Disposal and recycling

This unit contains recyclable materials.

Please note that the filters from this device must be discarded in accordance with the applicable national regulations for special solid waste.



Environmental implications: WEEE contains materials that are potentially hazardous to the environment and to human health. Therefore, when this instrument has reached its end of life it must be collected and recycled separately from other waste according to national requirements. Please contact a local CooperSurgical distributor for instructions. Do not dispose of with 'normal' waste.

12 Warranty information and limits on liability

Please refer to our Terms and Conditions on our website

fertility.cooperSurgical.com/commercial-terms-and-conditions/

13 Customer service contact details

Tel: +45 46 79 02 02

Fax: +45 46 79 03 02

E-mail: sales@coopersurgical.com

fertility.coopersurgical.com

Customer details for customers in the USA

Tel: 800-243-2974

Fax: 800-262-0105

fertility.coopersurgical.com